

Models/Modelos/Modèles
 P188624LF
 Series/Series/Seria

RP79826▲
 Handle Assembly with Set Screw,
 Button and Allen Wrench
 Ensemble de manette Avec Vis de
 fixation, Bouton et Llave Allen
 Mecanismo de llave con Tornillo de
 Ajuste, Botón y Clé Allen

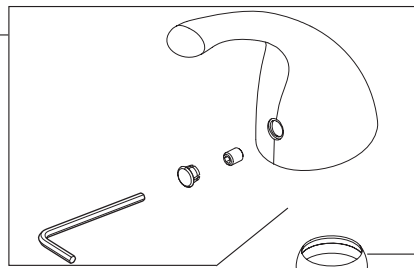

RP78361▲
 Lift Rod Assembly
 Barra de Alzar
 Tige de Manoeuvre



RP78355▲
 Cap
 Embase
 Casquillo

RP78353
 Bonnet Nut
 Écrou de chapeau
 Tuerca bonete

RP78367
 Cartridge
 Cartouche
 Cartucho

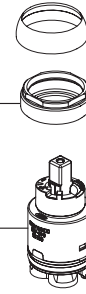

▲ Specify Finish
 Especificque el acabado
 Précisez la Finition

RP51345▲
RP51345▲-1.2
 Aerator & Wrench
 Aireador y Llave
 Aérateur et Clé

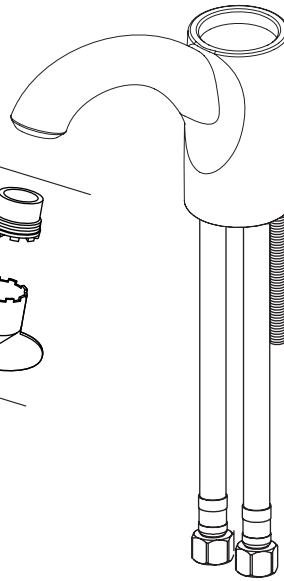
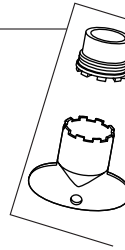

RP79827▲
 Spout Flange & Gasket (1 Hole)
 Brida y Empaque (1 agujeros)
 Bride et Joint (1 trous)



RP79825▲
 Escutcheon & Base Plate (3 Hole)
 Chapetón y Placa de Base (3 agujeros)
 Boîtier et Plaque de Finition (3 trous)

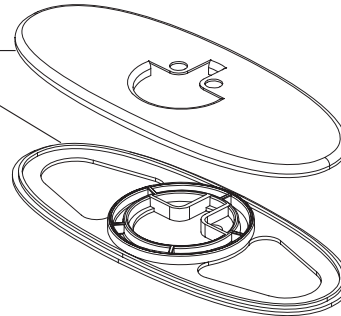

RP38958▲
 Pop-Up with Metal Flange and Plastic Tail Piece Less
 Lift Rod
 Drenaje automático con brida de metal y la pieza de
 cola plástica menos la barra de alzar
 Renvoi mécanique avec collerette en métal et
 raccord droit de vidange en plastique sans la tige de
 manoeuvre

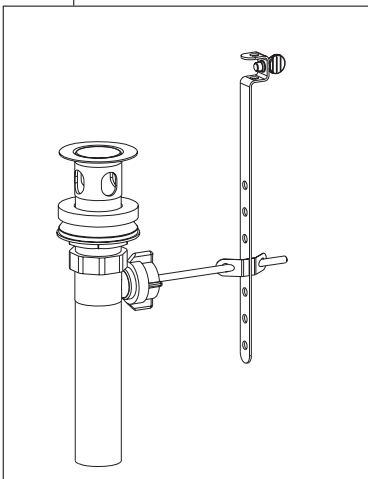

RP47029
 Bracket
 Abrazadera
 Support



RP47030
 Nut & Wrench Assembly
 Ensemble de Tuerca y Llave
 Écrou et clé

