

## USE AND CARE GUIDE

### LED PORTABLE TASK LIGHT

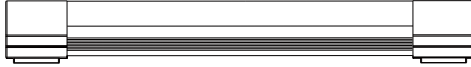

## Safety Information

Carefully read and understand the information in this manual before you operate this LED portable task light. Failure to do so could lead to a malfunction of the product or personal injury.

- CAUTION:** Do not stare directly into the LED portable task light when it is turned on as the LED portable task light is designed to have a high brightness mode.
- CAUTION:** Do not puncture, damage or dismantle the LED portable task light, and replace battery.
- CAUTION:** Keep the LED portable task light away from fire, erosive materials, corrosive and/or explosive gas, and chemical, medical and electronic devices, including magnetized data devices; hot steaming areas, as damage can occur.
- CAUTION:** Use the USB Cable provided in the package with an appropriate DC5V 1A charger.
- CAUTION:** The battery works on between 32°F (0°C) to 113°F (45°C), working outside the temperature may cause malfunction.
- CAUTION:** Do not use the LED portable task light when it is charging.
- CAUTION:** Avoid dropping the LED portable task light as damage to the PC cover or other electronic components can occur.
- CAUTION:** Handle the oxidized aluminum casing with care.
- CAUTION:** Test the adhesive strips on the adsorption platform before applying to avoid damage to the adsorption platform.
- CAUTION:** Use the adhesive strips to protect surfaces from potential scratches from the magnet on the LED portable task light.
- CAUTION:** Do not apply the adhesive strips in humid locations as the adhesive strips contain iron.
- WARNING:** Changes or modifications to this unit not expressly approved by the party responsible for compliance could void the user's authority to operate the equipment.

## Safety Information (continued)

**NOTICE:** Prolonged usage of the LED portable task light may increase the temperature of the LED portable task light to 122°F. This is normal and will not cause damage to the LED portable task light or hurt the user.

- NOTICE:** This equipment has been tested and found to comply with the limits for a Class B digital device, pursuant to Part 15 of the FCC Rules. These limits are designed to provide reasonable protection against harmful interference in a residential installation. This equipment generates, uses and can radiate radio frequency energy and, if not installed and used in accordance with the instructions, may cause harmful interference to radio communications. However, there is no guarantee that interference will not occur in a particular installation. If this equipment does cause harmful interference to radio or television reception, which can be determined by turning the equipment off and on, the user is encouraged to try to correct the interference by one or more of the following measures:
- Reorient or relocate the receiving antenna.
  - Increase the separation between the equipment and receiver.
  - Connect the equipment into an outlet on a circuit different from that to which the receiver is connected.
  - Consult the dealer or an experienced radio/TV technician for help.

## Limited Warranty

The manufacturer warrants this product to be free from defects in materials and workmanship for a period of one (1) year from date of purchase. This warranty applies only to the original consumer purchaser and only to products used in normal use and service. If this product is found to be defective, the manufacturer's only obligation, and your exclusive remedy, is the repair or replacement of the product at the manufacturer's discretion, provided that the product has not been damaged through misuse, abuse, accident, modifications, alterations, neglect or mishandling. This warranty shall not apply to any product that is found to have been improperly set-up or used in any way not in accordance with the instructions supplied with the product. This warranty shall not apply to a failure of the product as a result of an accident, misuse, abuse, negligence, alteration, or faulty installation, or any other failure not relating to faulty material workmanship. The manufacturer specifically disclaims any liability and shall not be liable for any consequential or incidental loss or damage, including labor/expense costs involved in the replacement or repair of said product.

Contact the Customer Service Team at 1-877-527-0313 or visit [www.HomeDepot.com](http://www.HomeDepot.com).

**THANK YOU**  
We appreciate the trust and confidence you have placed in Commercial Electric through the purchase of this LED portable task light. We strive to continually create quality products designed to enhance your home. Visit us online to see our full line of products available for your home improvement needs. Thank you for choosing Commercial Electric!

## Pre-operation (continued)

Lumens, Runtime [test under 77°F (25°C)], and Charging Time

Model WHQ20-40						
Mode	High	Mid	Low	Strobe	SOS	Charging
Lumens	360 Lm	180 Lm	50 Lm	N/A	N/A	N/A
Runtimes (hours)	3.5	7-8	34-35	14-15	15-16	4-5

## PACKAGE CONTENTS

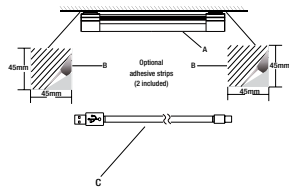

Part	LED Portable Task Light	Quantity
A	Handheld tube	1
B	Adhesive strips	2
C	USB cable	1

## Operation

### 1 Charging the LED portable task light

- The low power orange indicator light illuminates when the battery is less than 10% charged.
- Connect the USB cable (C) to the micro USB charger port on LED portable task light using an appropriate DC5V 1A charger.
- The recharging status indicator light is red during charging.
- LED portable task light turns green when fully charged.

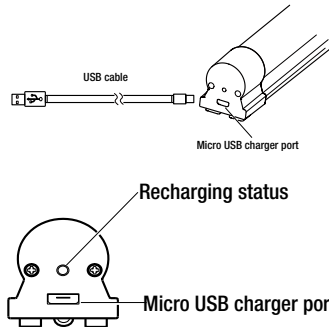

#### INDICATOR LIGHT STATUS

Indicator	Status
Red	Charging
Green	Fully Charged
Orange	Low Battery

### 2 Turning on the LED portable task light

- Press the power button to turn on the LED portable task light in high mode.

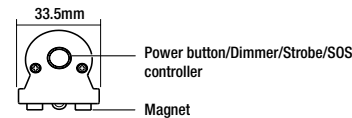

### 3 Changing the LED portable task light modes

- Press the power button once to turn the LED portable task light to high mode, twice for medium mode, and three times for low mode.
- Press and hold the power button for 2 seconds to turn on the strobe and hold 2 more seconds to start the SOS mode. These functions are available in all brightness modes.
- Press the power button once to return to high mode when using the strobe or SOS functions.

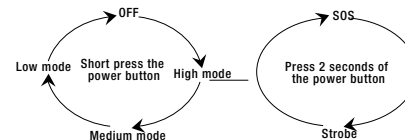

## Pre-operation

## SPECIFICATIONS

Body	8.5 in. (215 mm) handheld tube with Oxidized Aluminum, PC, ABS end cap with embedded magnet casing
LED	23 pcs, 6000 k – 6500 k
Wattage	3.8 W, Max.
Beam angle	110°
Adhesive strips	1.77 in. (45 mm) x 1.77 in. (45 mm)
USB cable	11.8 in. (300 mm) USB cable (Max. 1A)
Li-ion battery (embedded in tube)	Lithium Ion 4000 mAh, 70% efficiency after 300 full-cycle recharges
Charger (not included)	DC5V 1A

### 4 Positioning the LED portable task light

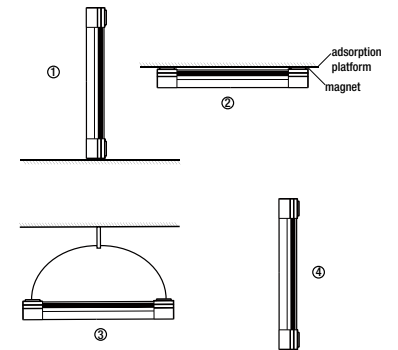

Position	Description
1	Stand upright.
2	Stick onto adsorption platform using the embedded magnets and adhesive strips (B).
3	Hang on the wall using a suspension string (not included).
4	Move freely in any hand-held position.

## Operation (continued)

### 5 Positioning the LED portable task light using adhesive strips

- Put the white, non-sticky side of the adhesive strip (B) onto one end of the LED portable task light. The white, non-sticky side of the adhesive strip (B) will automatically stick to the magnet at the end of the LED portable task light.
- Repeat for the second adhesive strip (B), placing it on the other end of the LED portable task light.
- Clean the flat surface of the adsorption platform.
- Peel off the bottom side of the adhesive strips (B) and press the LED portable task light onto the adsorption platform.
- Refer to Steps 1-3 to operate the LED portable task light.

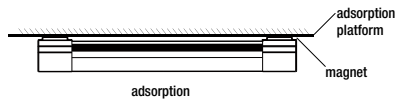

### 6 Removing the LED portable task light from the adhesive strips

- Press on the adhesive strips (B) firmly to make sure the back of the adhesive strips (B) stick to the adsorption platform tightly.
- Remove the LED portable task light from the adsorption platform as desired, leaving the adhesive strips (B) attached to the adsorption platform for future use.

## Care and Cleaning

- Wipe the LED portable task light with a piece of white tissue or soft cloth when dirty.
- Avoid spraying water on the LED portable task light and the micro USB charging port.

## Troubleshooting

Problem	Possible Cause	Solution
The body of the LED portable task light has some small and light scratches.	LED portable task light body is made with oxidized aluminum and like any normal aluminum tube, small scratches may be found.	Handle the LED portable task light body with care.
There are cracks in the magnet.	LED portable task light may have been dropped.	Protect the end cap when using and handling the LED portable task light.
LED portable task light does not switch on.	The battery level is low.	Check the low battery indication light, if the indicator light is on, charge the LED portable task light.
LED portable task light is becoming dimmer than normal standard.		

## Troubleshooting (continued)

Problem	Possible Cause	Solution
The recharging time is longer than the normal charging hours described in this manual.	The charger is incorrect.  The USB cable cannot accept 1A current.	Check whether the charger is DC5V 1A. If the charger is lower than 1A, it is normal for the charging time to be longer.  Check the USB cable for 1A current capability. If the cable cannot handle 1A current, replace with a different cable with that capacity.
LED portable task light becomes hot.	LED portable task light is operating outside of the normal temperature range.	If the temperature of the body is higher than 140°F (60°C) under normal working conditions, return the LED portable task light for a replacement if it is still within the warranty period.
LED portable task light does not work under very cold conditions.	The battery is cold.	Warm the LED portable task light to above 32°F (0°C).
LED portable task light requires more charging time and has a shorter runtime after a period of usage.	The battery life is depleted.	LED portable task light will function at 70% capacity with longer charging times and shorter runtimes. If this interferes with the performance you need for the LED portable task light, purchase a new light.

Problem	Possible Cause	Solution
The adhesive strips do not adhere to a surface.	The adhesive strips are worn out.	If the adhesive strips are older than 6 months, even if never used, purchase another set of adhesive strips. Adhesive strips are available for order at <a href="http://www.homedepot.com">www.homedepot.com</a> .
The indicator light flashes during the charging process.	The USB cable is loose.  The indicator light is out of order.	Tighten the USB cable or replace with a new one.  If the LED portable task light is within the warranty period, return the LED portable task light for a replacement.
The adhesive strips are difficult to remove.	The glue on the adhesive strips is very strong.	Use a thinner to dissolve the glue.
The surface is scratched after removal of the adhesive strips.	The glue on the adhesive strips is very strong.	Do not apply the adhesive strips to surfaces that can be scratched.



Questions, problems, missing parts? Before returning to the store, call CE Tech Customer Service  
8 a.m. - 7 p.m., EST, Monday - Friday, 9 a.m. - 6 p.m., EST, Saturday

1-877-527-0313  
HOMEDEPOT.COM